

# DIP Switches

## SMT Half Pitch Type DIP Switches

## DX48 Series

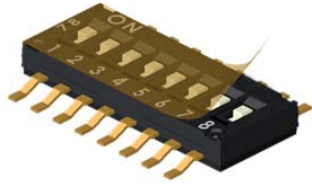

**DX48L**  
Terminal Length 8.1mm

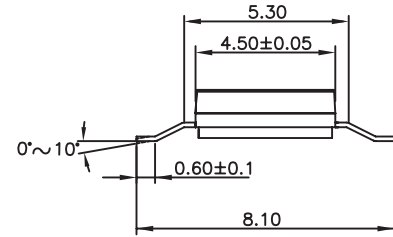
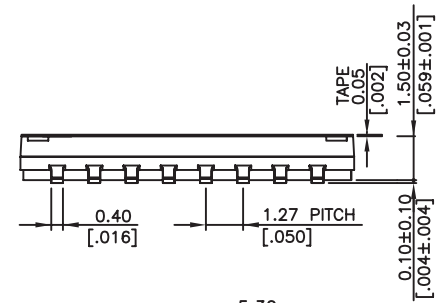
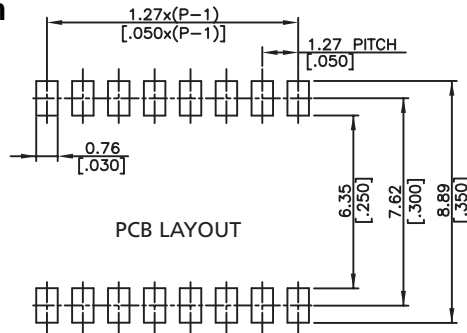
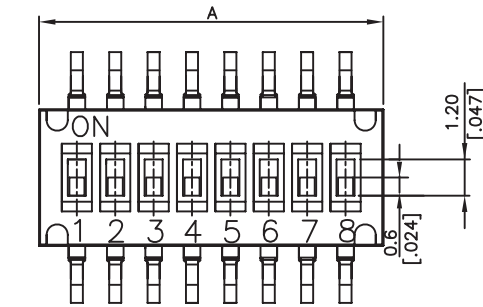
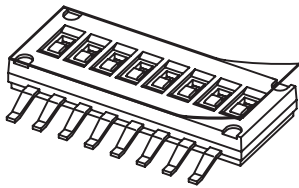

02	2	3.77 [.148]
04	4	6.31 [.248]
06	6	8.85 [.348]
08	8	11.39 [.448]
10	10	13.93 [.548]
CODE OF 2	NO. OF POS	DIM A



**DX48S**  
Terminal Length 6.7mm

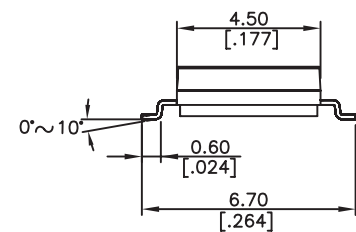
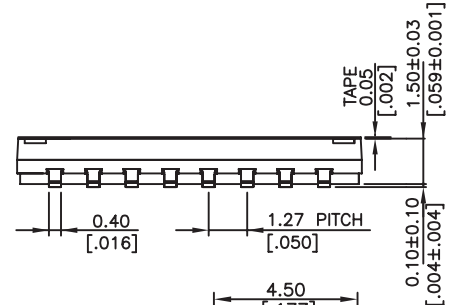
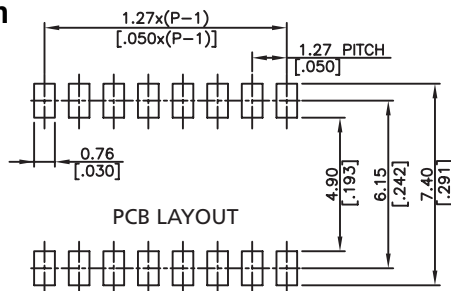
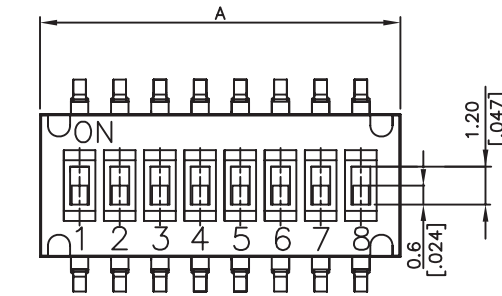
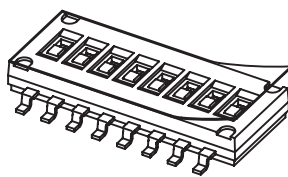

### How to order:

DX48

- |                            |                              |                         |
|----------------------------|------------------------------|-------------------------|
| <b>1</b> TERMINAL LENGTH:  | <b>3</b> ACTUATOR POSITION:  | <b>5</b> PACKAGE STYLE: |
| L 8.1 mm                   | F In OFF Position (Standard) | TB Tube                 |
| S 6.7 mm                   | O In ON Position             | TR Tape & Reel          |
| <b>2</b> NO. OF POSITIONS: | <b>4</b> SEAL:               |                         |
| 02 2 Positions             | N Regular (Standard)         |                         |
| 04 4 Positions             | T Top Tape Sealed            |                         |
| 06 6 Positions             |                              |                         |
| 08 8 Positions             |                              |                         |
| 10 10 Positions            |                              |                         |

NOTE: 1. ALL DIMENSIONS ARE IN MILLIMETERS, BRACKETED DIMENSIONS ARE IN INCHES.  
2. GENERAL TOLERANCE: ±0.2 mm

### Material:

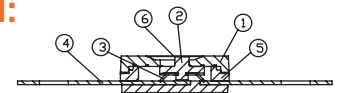

Item	Description	Materials	Treatment
1	Cover	High-Temp. Thermoplastic Nylon UL94V-0	Molded Black
2	Actuator	High-Temp. Thermoplastic LCP	Molded White
3	Contact	Phosphor Bronze	Gold Plated
4	Terminal	Brass	Gold Plated
5	Base	High-Temp. Thermoplastic Nylon UL94V-0	Molded Black
6	Tape	Katpon	

### SPECIFICATIONS

1. **Style:**

This specification describes "SMT HALF PITCH TYPE DIP SWITCHES" mainly used as signal switch of electric devices, with the general requirements of mechanical and electrical characteristics.

1.1 Operating Temperature Range : -40°C ~+85°C

1.2 Storage Temperature Range : -40°C ~+85°C

2. **Current Range:**

2.1 Non-Switching: 100mA, 50V DC

2.2 Switching: 25mA, 24V DC

3. **Type of Actuation:** Actuated by sliding

4. **Test Sequence:**

	ITEM	DESCRIPTION	TEST CONDITIONS	REQUIREMENTS
<b>MELECTRIC PERFORMANCE</b>	1.	Visual Examination	By visual examination check without any out pressure & testing.	There shall be no defects that affect the serviceability of the product.
	2.	Contact Resistance	1)To be measured between the two terminals associated with each switch pole. 2)Measurements shall be made with a 1 kHz shall current contact resistance meter.	100mΩ max. (initial)
	3.	Insulation Resistance	500 V DC , 1 minute±5 sec.	100MΩ min
	4.	Dielectric withstanding Voltage	300 V AC (50Hz or 60 Hz) shall be applied between all the adjacent terminals and between the terminal and the frame for 1 minute.	There shall be no breakdown or flashover.
	5.	Capacitance	1MHz±10kHz	5 pF max.

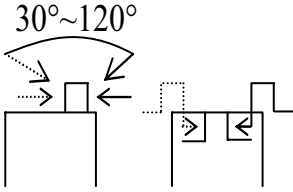
<b>MECHANICAL PERFORMANCE</b>	6	Operation Force	<p>Applied in the direction of operation. ON→OFF OFF→ON</p> 	500 gf max (4.9N max)	
	7	Stop Strength	1 kgf is applied in the operating direction and pulling direction operated for a period of 15 seconds.	There shall be no sign of damage mechanically.	
	8	Soldering Heat Resistance	1)Soldering Temperature :		1)As shown in item 3~6 2)Contact Resistance: 2Ω max. (final-after test)
			PROD SERIES	SMT TYPE TERMINAL	
			TEMP	260±5°C	
TIME			5~10sce		
2)Duration of Solder Immersion: 5±1seconds. 3)Frequency of Solder Process: 1 times max. (PCB is 1.6 mm in thickness.)					
9	Vibration	Shall be vibrated in accordance with Method 201A of MIL-STD-202F 1)Frequency: 10-55-10 Hz 1 min/cycle. 2)Direction: 3 vertical directions including the direction of operation 3)Test Time: 2 hours each direction.	1)As shown in item 2~6 2)Contact Resistance: 2Ω max.) (final-after test)		
10	Shock	Shall be shocked in accordance with Method 213B Condition A of MIL-STD-202F 1)Acceleration : 50G 2)Action Time : 11±1 m seconds 3)Testing Direction : 6 sides 4)Test cycle : 3 times in each direction	1)As shown in item 2~6 2)Contact Resistance: 2Ω max. (final-after test)		

<b>DURABILITY</b>	11	Operation Life	<p>Measurements shall be made following the test set forth below:</p> <p>1)25mA,24 V DC resistive load                      2)Rate of Operation : 15~20 cycles/minute                      3)Cycle of Operation : 1000 cycles</p>	<p>1)As shown in item 3,4                      2)Contact Resistance: 2Ω max. (final-after test)</p>
<b>WEATHER-PROOF</b>	12	Resistance Low Temperature	<p>Following the test set forth below the sample shall be left in normal temperature and humidity conditions for an hour before measurements are made :</p> <p>1)Temperature : <math>-40\pm 3^{\circ}\text{C}</math>                      2)Time : 96 hours</p>	<p>1)As shown in item 2~6                      2)Contact Resistance: 2Ω max. (final-after test)</p>
	13	Resistance High Temperature	<p>Following the test set forth below the sample shall be left in normal temperature and humidity conditions for an hour before measurements are made :</p> <p>1)Temperature : <math>85\pm 2^{\circ}\text{C}</math>                      2)Time : 96 hours</p>	<p>1)As shown in item 3~6                      2)Contact Resistance : 2Ωmax. (final-after test)</p>
	14	Resistance Humidity	<p>Following the test set forth below the sample shall be left in normal temperature and humidity conditions for an hour before measurements are made :</p> <p>1)Temperature : <math>40\pm 2^{\circ}\text{C}</math>                      2)Relative Humidity : 90~95%                      3)Time : 96 hours</p>	<p>1)As shown in item 4~6                      2)Contact Resistance : 2Ωmax.                      3)Insulation Resistance: 10 MΩ min .</p>

### 5. SOLDERING CONDITIONS:

#### ■ Condition for Soldering

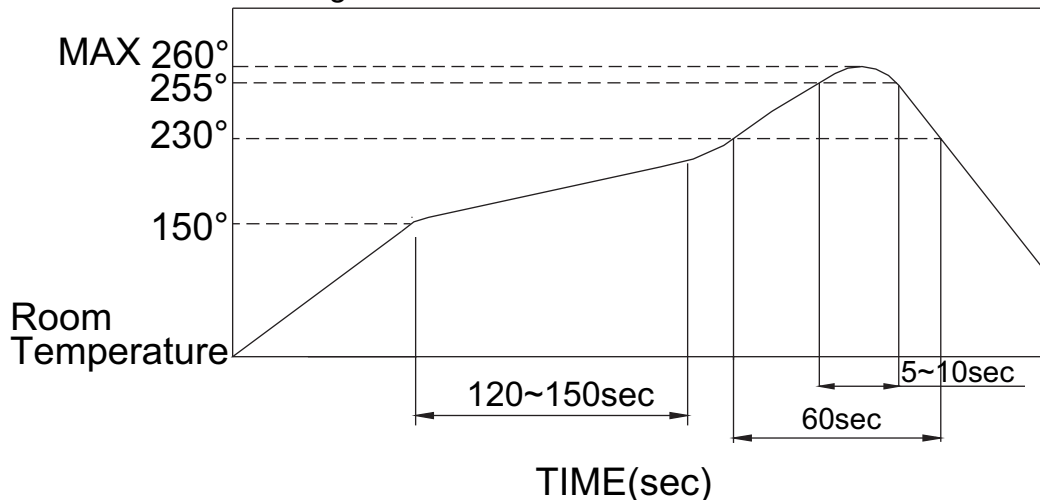

- The condition mentioned above is the temperature on the Cu foil of the PCB surface. There are cases where board's temperature greatly differs from switch's surface temperature depending on board's material, size, thickness, etc. Care, therefore, should be used not to allow switch's surface temperature to exceed 260°C.

#### ■ Manual Soldering

Soldering Temperature	Max,350°C
Continuous Soldering Time	Max,5 seconds

#### ■ Precautions in Handling

1. Care should be exercised so that flux from the upper part of the printed circuit board does not adhere to the switch.
2. Don't clean the switch body except with top tape sealed type, which can only spray of cleaning method from top of s/w.
3. Slide the DX48 actuator from Z axial direction with in 30°~120° of max 300 gf / 10 sec operation.

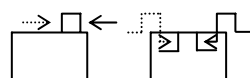

4. The suggest tool for actuator adjust is as below. ( example for 4 position )

